

**TESSERA<sup>4</sup>**  
OFF ROAD ACCESSORIES

**4x4**  
*Think Quality!*



Tessera4x4

**“REVOLUTIONIZING THE 4X4 INDUSTRY”**

**Discover the Future of 4x4 Accessories with Tesseract4x4**

**TESSERA**

**TIME TO MAKE A STATEMENT!**

**Unmatched Innovation & Excellence  
for Your Pickup Truck.**





**DETAILS MATTER...**



**SIDE RAIL PARTS  
WITH BUILT-IN T-SLOTS**

**Experience Easy & Secure  
Installation with NO DRILL  
for Your Accessories.**





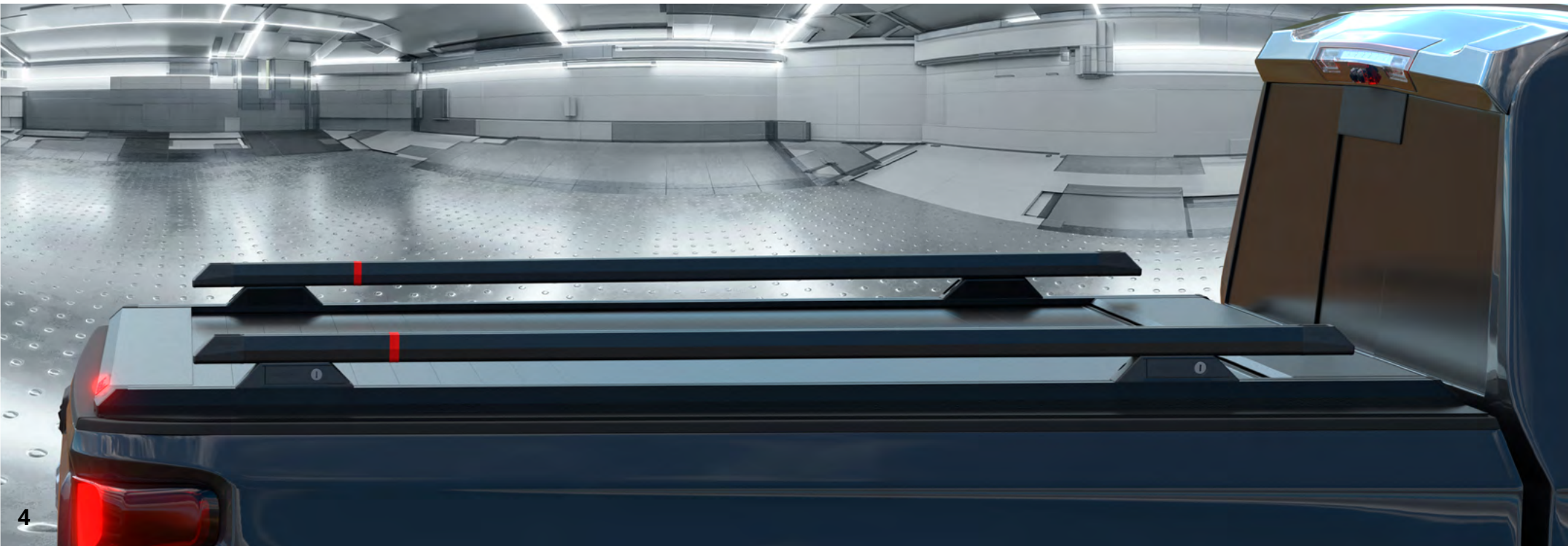



**DISCOVER THE UNRIVALED  
ELEGANCE OF TESSERA4X4:**

**Complete Collection of Premium,  
One-of-a-Kind Accessories for Your  
Pickup Truck.**





## TOP-TIER 4X4 ACCESSORIES

For Every Adventure.  
We've Got Your Perfect Solution!











**Mobile App:  
Intelligent  
Control  
at Your  
Fingertips.**



**Key Fob  
Remote:  
Crafted for  
Effortless  
Convenience.**

## Tessera Roll+ 4 Operational Modes



**Unique rear slat  
that also  
functions as an  
open-close  
switch.**



**Voice Command  
Mode: Elevated  
Hands-Free  
Control.**



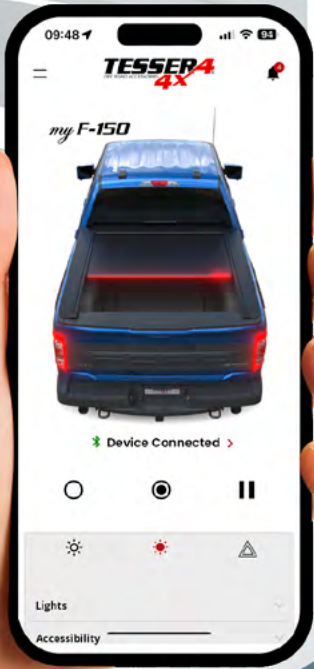

Real Time animation & notifications



# TESSERA Roll+ Mobile App:

## Revolutionizing Your Daily Experience with Seamless Configurations and Interactions!

Customizable Controls

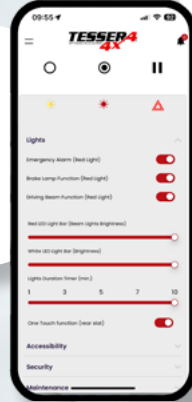

Hands-Free Voice Commands

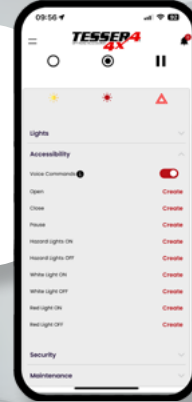

Ultimate Security Protection Settings



Event log history for easier serviceability

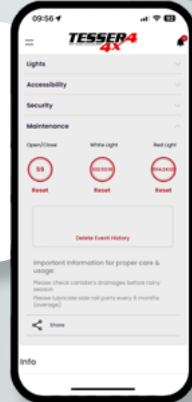

Elevate Your Roll Top Experience with Exclusive FW Board Updates!

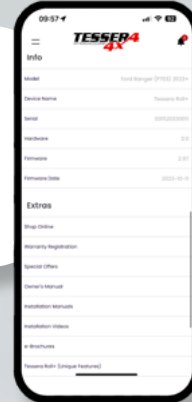

Multi-car garage function

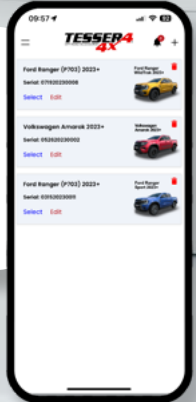

Dealer locator



Latest news notifications



Account management

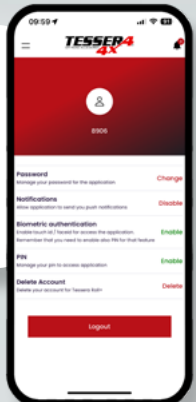



# 3 in 1 Mod

## Tessera Roll+ BASIC VERSION

- **Unique, smooth, easy opening system without any assistance.**
- **Unique design - upgrade anytime.** Easy upgrade from **Basic to Spring or Electric version** by **JUST** adding the kit of your preference. Easy downgrade whenever needed.
- **Basic version, is the base of all versions.** Distributors and wholesalers can stock **1 SKU** (basic version) and add the **E-Kit** or **S-Kit** whenever needed, thus decreasing the number of SKUs by almost **2 times**.



### BASIC VERSION + S-KIT ⚙️



- **Upgrade from Basic to Spring version** by simply adding the **S-Kit**.
- **Spring-assisted opening** for an even easier opening.



### BASIC VERSION + E-KIT ⚡



- **Upgrade from the Basic version** to the AI-Powered version using the **E-Kit**.
- Put the **power of AI** at your fingertips with a host of benefits such as:
  - **Open and close** your roll top cover using the specially designed **key fob**, **one-touch** rear slat, the unique **Tessera Roll+ App** or simply using **voice commands**.
  - **Forgot** your roll top cover open? Tessera Roll+ App will **remind you to close it**.
  - **Maintenance** notifications.
- **Use the power of AI** for your convenience, ease of use, and infinite possibilities of customization.
- **Proximity** safety sensors.
- **No need** for motor calibration.

In addition to a host of other features and benefits that would amaze and surprise anyone that they could be incorporated in a roll-top cover.





# ular Design

**BASIC VERSION**



**BASIC VERSION + S-KIT**

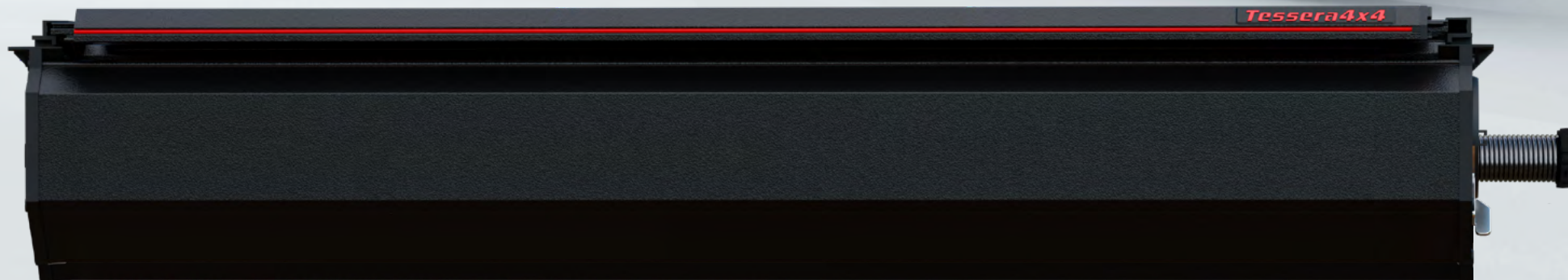

**BASIC VERSION + E-KIT**

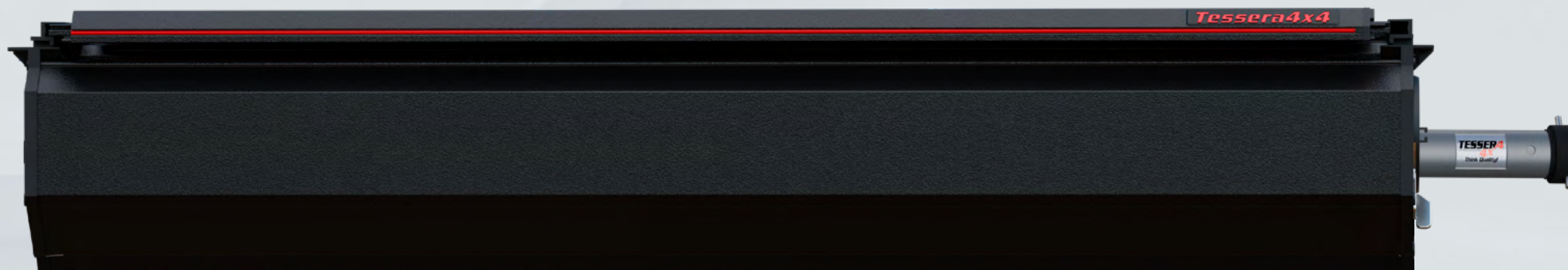



## **SEALED & PROTECTED ELECTRIC MOTOR**

**Housed in a Heavy-Duty  
Aluminum Central Shaft  
for Ultimate Protection  
and Compact Design.**

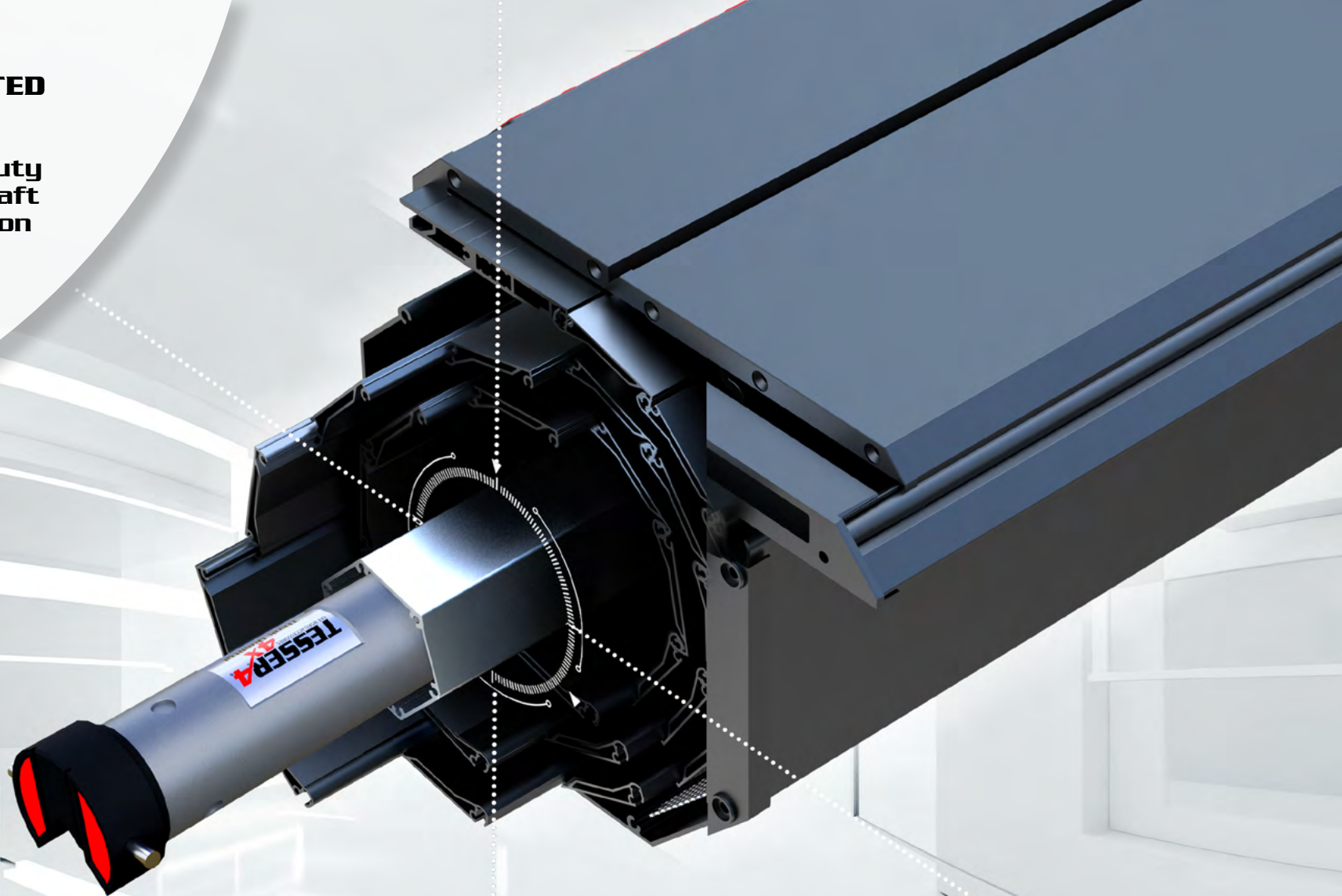



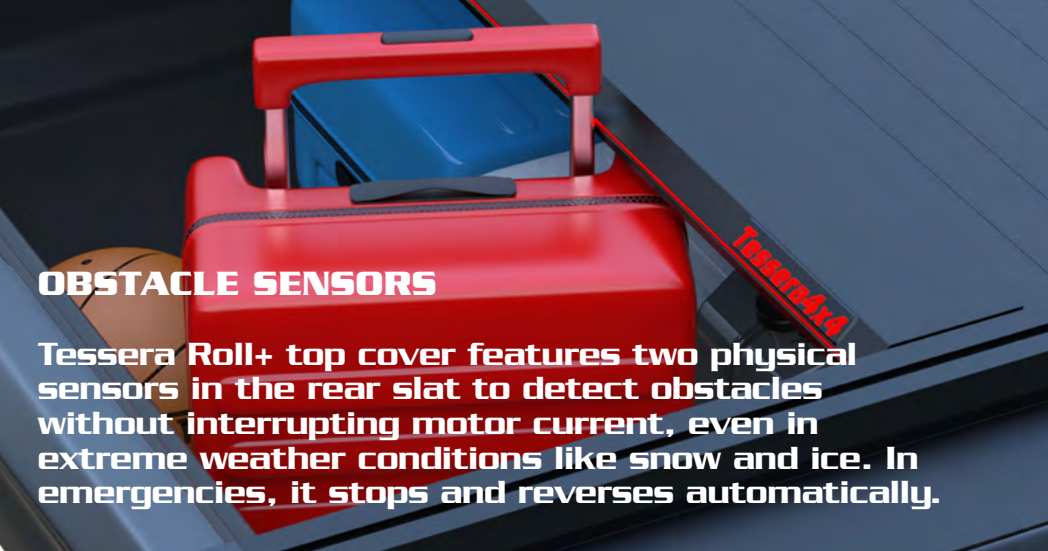

### **OBSTACLE SENSORS**

Tesseract Roll+ top cover features two physical sensors in the rear slat to detect obstacles without interrupting motor current, even in extreme weather conditions like snow and ice. In emergencies, it stops and reverses automatically.



Easy access to canister body.



### **VERSATILE RED LED LIGHT BAR**

Stylish and Functional Red LED Light Bar. Use it as a beam light, brake light, obstacle warning flash alert (with E-Kit), or hazard light for ultimate safety and visibility.

### **VERSATILE WHITE LED INTERIOR LIGHT BAR**

Experience the Innovative Full-Length White LED Light Bar with Spot-and-Focus Function, Perfectly Illuminating Every Corner of Your Truck Bed, Regardless of the Load.



## INNOVATIVE REAR SLAT DESIGN

*Maximize Your Load Capacity in Both Length and Height with Our Specially Designed Rear Slat, Now Ingeniously Positioned Inside the Canister Area.*

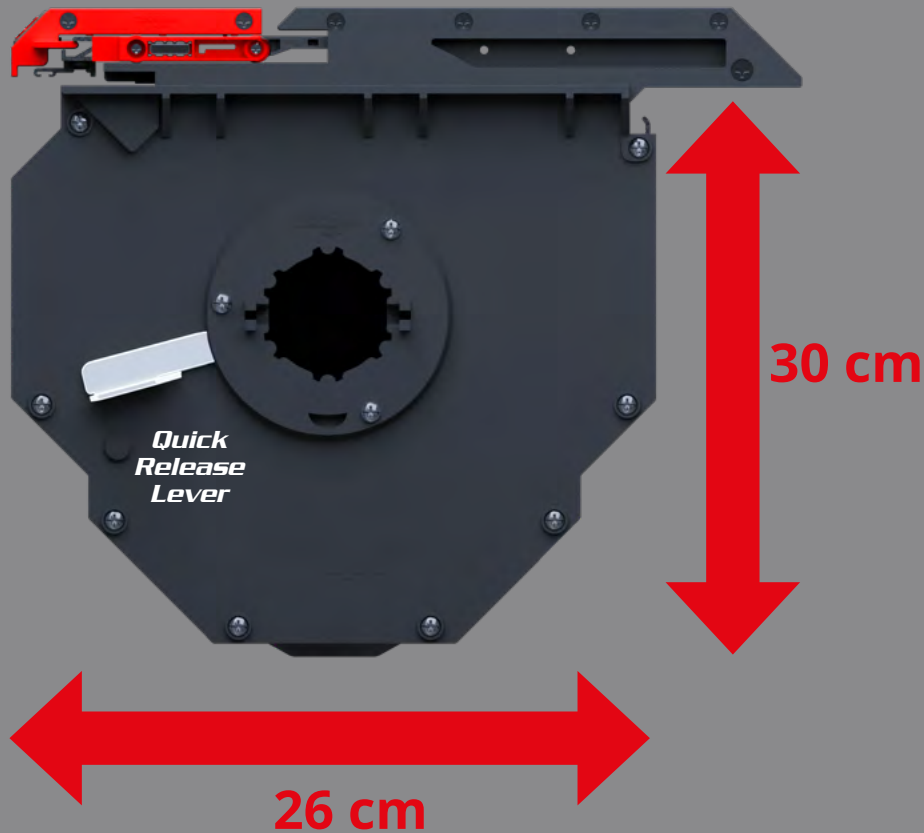

\*\*\* For Mid-Size Pickup Trucks 20cm x 23cm (HxW)

## KNIFE-PROOF SLATS

**Specially Designed for Ultimate Security, Ensuring 100% Protection for Your Load.**



**Interior Locking system for preventing unauthorised access.**



## ALUMINUM LOCKING TEETH

**Experience Maximum Security with Our Unique Interior Automatic Locking System Featuring Durable Aluminum Locking Teeth – No Plastic, Just Pure Strength.**

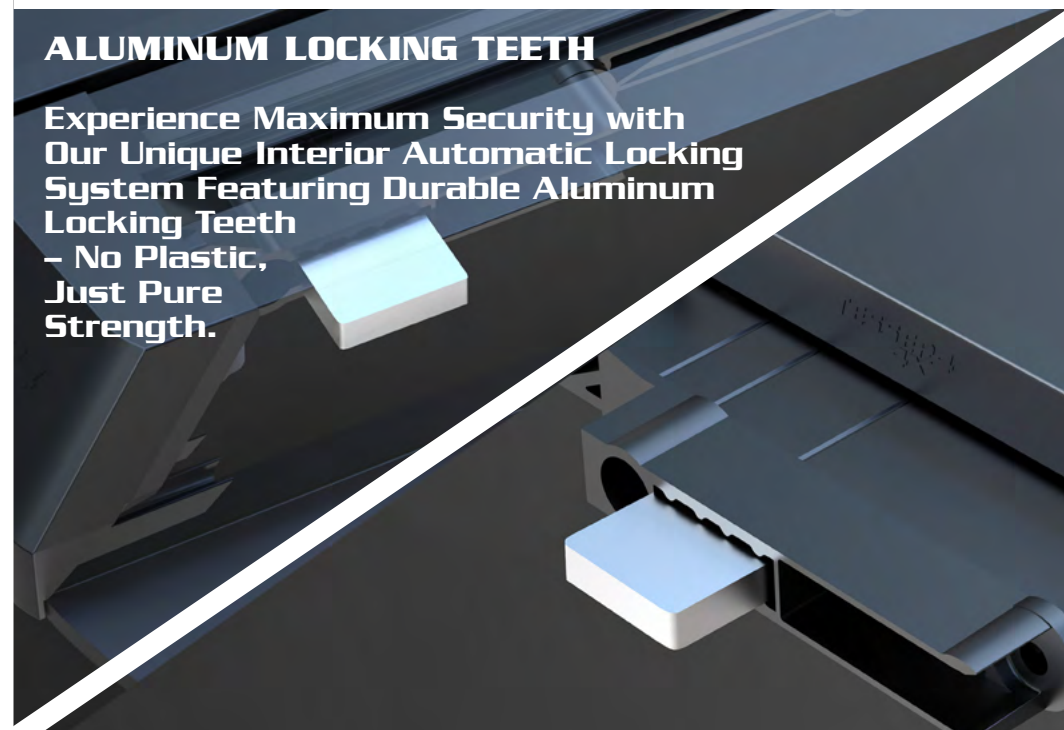





**SUPERIOR  
WATER PROTECTION**

Featuring Two Oversized  
Drainage Systems for Rapid  
Water Removal and Dual  
Overflow Systems in the Canister  
Body for Unmatched Water  
Resistance.



**ENHANCED DRAINAGE SYSTEM**

Large Drainage Channels in  
Side Rail Parts Ensure Maximum  
Water Removal Efficiency.



**UNIQUE ANTI-LEAF SYSTEM**

The World's Only Roll Top  
Cover with a Specially  
Designed Anti-Obstruction  
System to Keep Canister  
Water Drains Clear of Leaves and Debris.

The Ultimate  
weather  
protection  
systems.





# Tessera Bar+

The First **2-in-1** Telescopic Cross Bars that Transform into Side Handrails in Under a Minute.

• Cross Bars

**2 in 1**

• Side Bars





# Tessera Divider+

The Ultimate  
**2-in-1** Modular Trunk  
Solution for Your  
Pickup Truck.  
From Divider  
to side Molle  
panels.

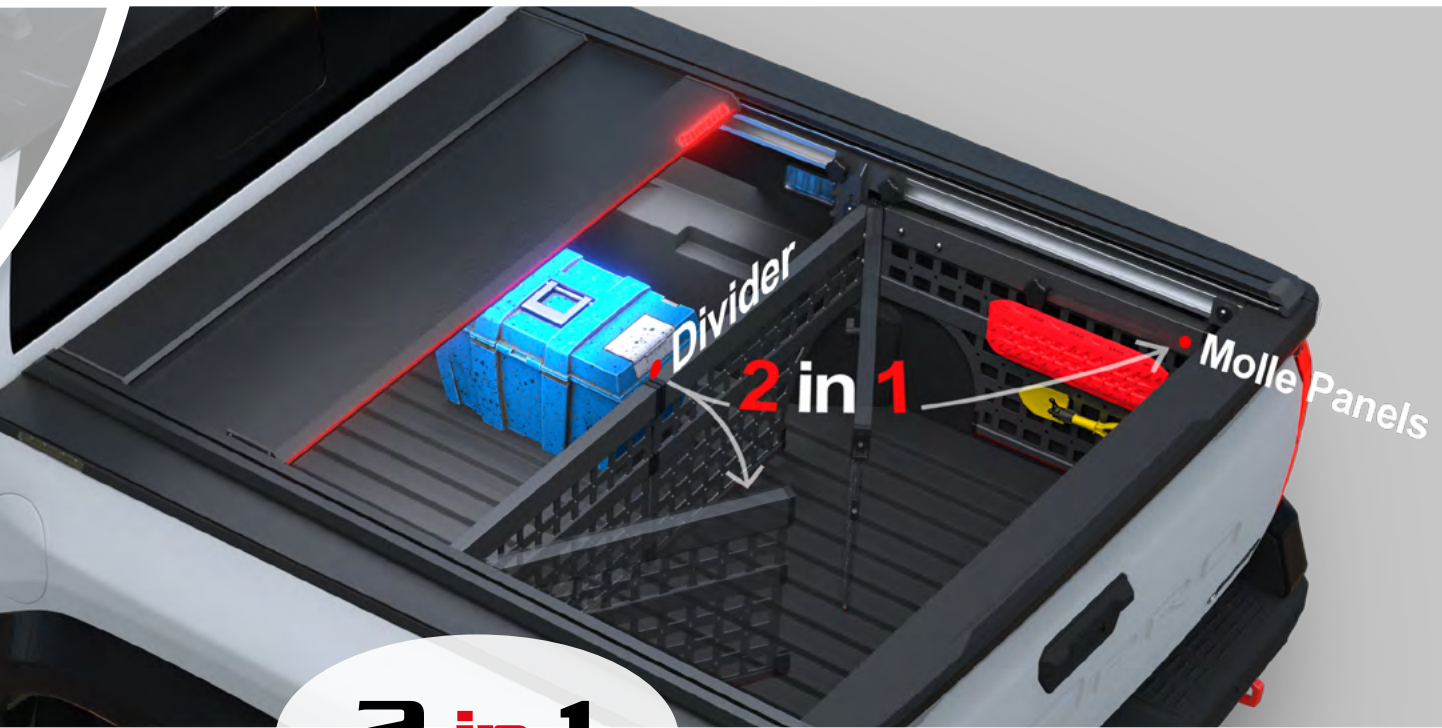

2 in 1

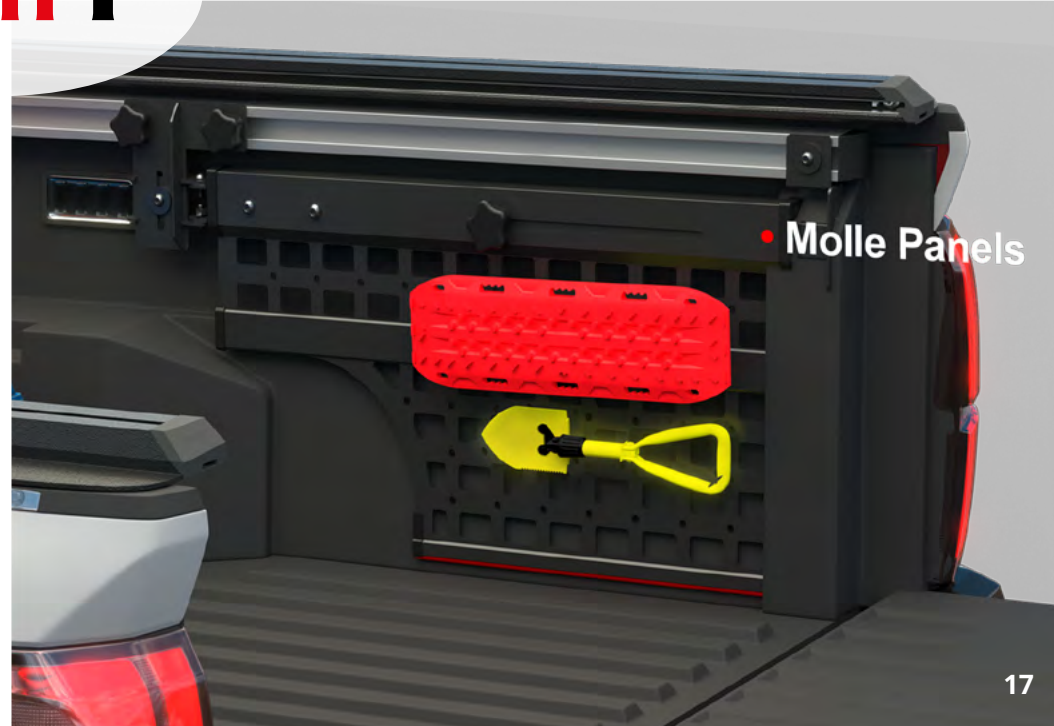
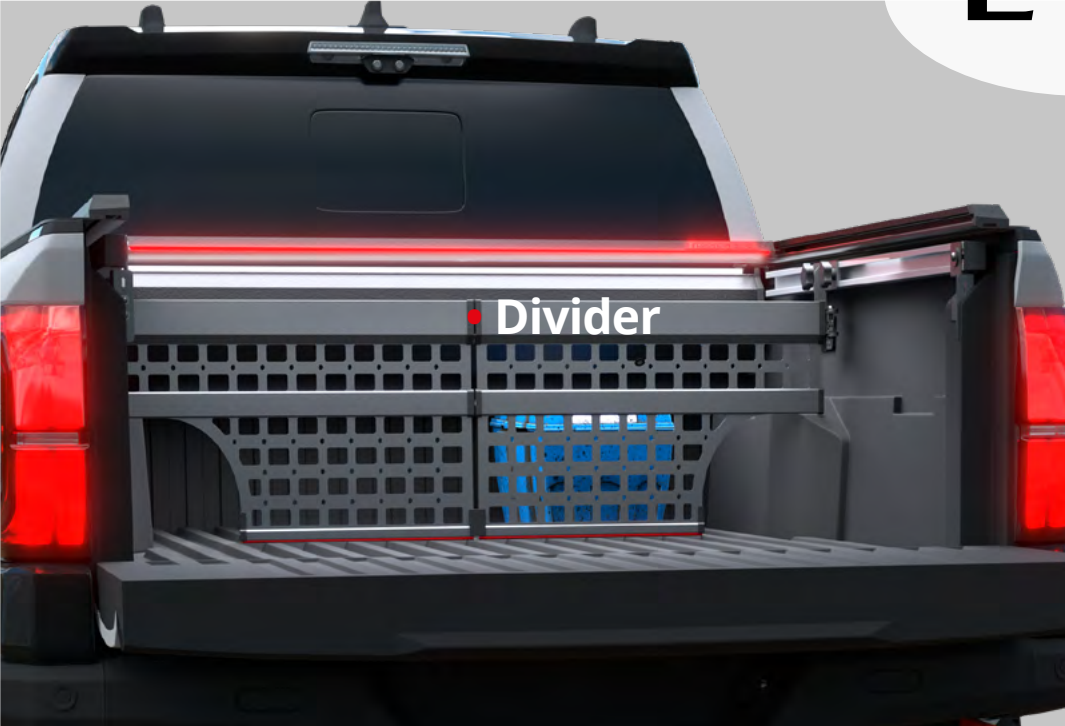



<b>Why Tessera Roll+? Top Benefits</b>	<b>Wholesalers</b>	<b>End customers</b>	<b>Competition</b>
<ul style="list-style-type: none"> <li>● <b>Modular Design 3 in 1</b> By ordering just 1 product code per model, Tessera Roll+ could be transformed to 3 different product codes. This means:</li> </ul>	✓	✓	✗
✓ No need of three times more space to warehouse	✓	—	✗
✓ Three times less shipping costs	✓	—	✗
✓ Lower risk for remaining stock (1 product vs 3)	✓	—	✗
✓ Easier order forecast	✓	—	✗
✓ Easy transformation with s-kit or e-kit with no use of tools (Quick Release Lever) or special knowledge	✓	✓	✗
✓ Gives the benefit to the end customer to upgrade his Tessera Roll+ at any time	✓	✓	✗
<ul style="list-style-type: none"> <li>● <b>Smart AI Control Board</b> The only roll top cover in the global market with Artificial Intelligence board. This means:</li> </ul>	✓	✓	✗
✓ <b>Auto calibration of motor</b> (no need of a special procedure in case of first fitting, replacement of motor and in case in low temperatures)	✓	✓	✗
✓ <b>Maintenance alerts</b> The most common claims for all roll top covers around the world are for maintenance. For the end users is not easy to remember to follow the proper care and usage instructions and as a result they identify or realise the problems too late. As a consequence they will have to be charged for additional costs of the damaged spare parts or they won't have the proper functionality to their roll tops. Now Tessera Roll+ users have the advantage to receive pop up maintenance alerts directly to their mobile as they stay connected with their Tessera Roll+ all the time. So they will be notified for the most important and common issues like:	✓	✓	✗
a) <b>Canister's cleaning</b> In case of blocked water inside the canister's area (it prevents problems to the whole structure or in cases with spring/motor)	✓	✓	✗
b) <b>Side rails parts cleaning &amp; lubricating</b> It calculates the time that the roll needs to open and close and after 10 confirmations it notifies you that the standard period is exceeded	✓	✓	✗
c) <b>Motor failure</b>	✓	✓	✗
✓ <b>Share event history</b> Tessera Roll+ users can view and share the event history and functionality of their roll. This means the best after sales care service that the final users could imagine	✓	✓	✗
✓ <b>4 MODES of operation</b>	✓	✓	✗
a) <b>Specially designed remote controls</b>	✓	✓	✗
b) <b>Tessera Roll+ Mobile app</b>	✓	✓	✗
c) <b>Voice Commands</b>	✓	✓	✗
d) <b>The unique "ONE Touch" function.</b> This means that the rear slat functions as huge aluminium button (there are not physical buttons to the side rails like in competition where are not working in low temperatures and are easy to be damaged as they are exposed to weather conditions and in case of stealing)	✓	✓	✗
<ul style="list-style-type: none"> <li>● <b>Electricity to rolling part</b> Tessera4x4 is the only company in the world that managed to transform electricity to the rolling part and as a result:</li> </ul>	✓	✓	✗

<b>Why Tessera Roll+? Top Benefits</b>	<b>Wholesalers</b>	<b>End customers</b>	<b>Competition</b>
a) <b>To put a beautiful and practical RED LED LIGHT BAR</b> , that can be used as a beam light, brake light, and in case of E-Kit as an obstacle warning flash alert or even as a hazard light	✓	✓	✗
b) <b>To have a moving full-length WHITE LED LIGHT BAR</b> located inside the rear slat with our unique spot-and-focus function to focus the light on any area or item inside the trunk, eliminating any dark spots in the truck bed	✓	✓	✗
c) <b>To put physical sensors</b> into the end slat as a result to function as physical main control button and as an obstacle sensors	✓	✓	✗
● <b>Obstacle physical sensors</b> Since physical sensors are embedded to the end slat, Tessera Roll+ senses directly (in real time) the obstacle with no use of motor current. All the competition uses the motor current to sense obstacles which means that they are not 100% secure especially in children's cases. Also, by using motor current then the motor will be damaged quicker	✓	✓	✗
● <b>Heavy-duty shaft</b> Located inside canister's area. Within shaft could be located the spring (s-Kit) or electric motor (e-Kit), to be sealed and protected. As a result, we take no extra space of the trunk area to put motor (in comparison with the competition located in a separate side box outside the canister or located in 2nd shaft with bigger canister) or unprotected to the trunk bed	✓	✓	✗
● <b>Innovative design &amp; Compact size</b> Rear slat goes inside to the canister's area in combination of the smallest canister's dimensions (20cm x 23cm) (Space cab / Single cab / American models 26cm x 30cm (HxW)), offers the advantage of maximizing load net capacity both in length and height. In comparison with the competition that the end slat exceeds from the canister area	✓	✓	✗
● <b>Mobile App Configurations</b> Experience a whole new environment of configurations	✓	✓	✗
a) <b>Lights adjustments like:</b> on/off, brightness of red/white lights, timer of lights, etc.	✓	✓	✗
b) <b>Easy pairing of new remote controls</b> in case of lost remote controls	✓	✓	✗
c) <b>Many security settings</b> (like left opened Reminder, Double-Click function, etc.,)	✓	✓	✗
d) <b>Monitoring your Tessera Roll+</b> operation circles, lights and share events	✓	✓	✗
e) <b>Online</b> installation guides, videos, brochures and closest dealers support	✓	✓	✗
● <b>The one and only Anti-Leaf System (ALS)</b> Tessera Roll+ is the only roll top cover in the global market with a specially made obstruction system (anti-leaf system), to protect the water drains of canister from leaves and small trash	✓	✓	✗
● <b>Side rail parts (5mm thickness)</b> Specially made (100% handmade) side rails with 5mm thickness, which follows 100% the shape and the design of the trunk's rail parts (in length and width). This offers the following benefits:	✓	✓	✗
a) <b>Better insulation</b> from any weather conditions	✓	✓	✗
b) <b>Reinforce</b> the vehicle's rail parts	✓	✓	✗
c) <b>Free surface to drill</b> in order to install all types of roll bars, side handrails and loading bars (in cases of heavy usage)	✓	✓	✗
● <b>Aluminium Locking Teeth (ALT)</b> The only roll top cover with "AUTOMATIC ALUMINIUM" locking teeth for maximum security (no plastic) of the load	✓	✓	✗



Summary Features List (per version of Tessera Roll+ & SE series)	Basic Version	Basic version + S-Kit	Basic version + E-Kit	Tessera SE Manual
<b>Motion</b>				
✓ Manual (no spring/no motor)	✓			✓
✓ Spring		✓		
✓ Motor			✓	
<b>Operation</b>				
✓ Strap (Manual)	✓	✓		✓
✓ 4 MODES of operation (Remote control/Mobile App/Voice Commands/One Touch)			✓	
<b>Lights</b>				
● Red Led Light Bar:	✓	✓	✓	
✓ Beam light	✓	✓	✓	
✓ Beam light ON/OFF (Mobile App)			✓	
✓ Brake light	✓	✓	✓	
✓ Brake light ON/OFF (Mobile App)			✓	
✓ Emergency hazard lights system			✓	
✓ Emergency hazard lights system ON/OFF (Mobile App)			✓	
✓ Obstacle warning flash alert			✓	
✓ Adjust brightness of beam lights			✓	
● White Led Light Bar:	✓	✓	✓	
✓ Switch ON/OFF	✓	✓	✓	
✓ Remote control ON/OFF			✓	
✓ Mobile App ON/OFF			✓	
✓ Timer configuration (min.)			✓	
✓ Adjust brightness			✓	
<b>Security   Protection</b>				
✓ Obstacle feature (with physical sensors)			✓	
✓ Auto stop & locking feature			✓	
✓ Knife proof slats	✓	✓	✓	✓
✓ Internal Locking System (ILS)	✓	✓	✓	✓
✓ Aluminium Locking Teeth (ALT)	✓	✓	✓	✓
✓ Central shaft (Direct Drive System)	✓	✓	✓	
✓ Electric motor & spring (DDS) located to shaft		✓	✓	
✓ Side rail drainages	✓	✓	✓	✓
✓ 2 main drains into the canister area Ø20	✓	✓	✓	✓

Summary Features List (per version of Tessera Roll+ & SE series)	Basic Version	Basic version + S-Kit	Basic version + E-Kit	Tessera SE Manual
✓ Anti-Leaf System (ALS)	✓	✓	✓	✓
✓ Slats with embedded silicon seal	✓	✓	✓	✓
✓ Biometric authentication to App, Pin code to App, Bluetooth pin to App			✓	
✓ Double-Click function			✓	
✓ Tessera Roll+ left opened Reminder			✓	
<b>Practicality</b>				
✓ 3 in 1 Modular Design (Quick Lever)	✓	✓	✓	
✓ No need motor calibration			✓	
✓ Soft open/close feature			✓	
✓ Auto stop & locking feature			✓	
✓ Voice Commands with Siri/Google Assistant etc.,.			✓	
✓ ONE Touch function ON/OFF			✓	
✓ Smallest canister's dimensions (Double cabs: 20cm x 23cm & Space/Single/American models: 26cm x 30cm)	✓	✓	✓	✓
✓ Specially made side rail parts (5mm thickness)	✓	✓	✓	✓
✓ Quick installation	✓	✓	✓	✓
✓ Installation with all types of Bedliners (over/under rail)	✓	✓	✓	✓
✓ T-slots rack for NO Drill accessories	✓	✓	✓	✓
✓ Installation kit for roll bars & side handrails with <b>NO Drill</b> (light use max 70kg)	✓	✓	✓	✓
✓ Vertical clearance	✓	✓	✓	✓
✓ Aerodynamics to boost fuel economy	✓	✓	✓	✓
<b>Maintenance</b>				
✓ Maintenance pop up alerts (Blocked water in canister, clean & lubricate side rails & motor failure)			✓	
✓ Operation circles (roll open-close, lights time)			✓	
✓ Share event history of general operation			✓	
✓ New remote controls pairing			✓	
✓ Clear paired remote controls			✓	
✓ Bluetooth ON/OFF			✓	
✓ Easy access to canister's body any time	✓	✓	✓	✓
✓ Maintenance Free (DTS) in transmission system	✓	✓	✓	
✓ Next generation powder coat finish	✓	✓	✓	✓
<b>Patents   Certificates</b>				
✓ 8 Patents	✓	✓	✓	5 Patents
✓ 3 Certificates	✓	✓	✓	✓



## The First AI-Powered Tessera Roll+ Series:

Introducing Tessera Roll+: Your Pickup's Ultimate Upgrade.

For the first time ever, Tessera Roll+ sets a new standard as the only roll top cover worldwide to incorporate Artificial Intelligence, revolutionizing convenience, maintenance, security, and customization.

With 8 patents and meticulous Greek craftsmanship, each Tessera Roll+ boasts unmatched quality and finish.



- Upgrade from manual to **spring-assisted or AI electrical operation**, or even downgrade at your convenience, making it budget-friendly for retail customers and efficient for wholesalers.
- **Harness the power of AI for seamless operation**, proactive maintenance notifications, and four modes of operation, including **Key Fob Remote, One-Touch Rear Slat, Tessera Roll+ App, or Voice Commands**.
- **Protect your loved ones with proximity sensors** and enhance safety and style with a versatile red LED light bar.
- **Crafted from nearly 50-60kg of aluminum, Tessera Roll+** withstands extreme conditions with oversized drains, anti-leaf system, water-resistant design, & knife-proof slats.
- **Elevate your pickup truck with Tessera Roll+** – the toughest, most feature-rich roll top cover on the market, delivering functionality and style in one sleek package.

---

**Upgrade your vehicle with Tessera ROLL+ & experience the pinnacle of style, versatility, & durability in roller lid shutters.**

## The Ultimate Tessera SE Series:

The Premium Manual Retractable Tonneau Bed Cover for Professionals

Discover the Tessera SE: Efficiency, Practicality, and Premium Design. Welcome the latest innovation from Tessera4x4: the Tessera SE manual retractable tonneau bed cover, designed to meet the high standards of professionals who demand the best. Combining superior quality, unmatched practicality, & cutting-edge design, the Tessera SE is your ultimate choice for all pickup trucks.



### Key Features and Benefits of Tessera SE

- 1. Unique Easy Opening System:** Effortlessly open and close your tonneau cover without the springs or electric motors, ensuring a seamless experience.
- 2. Superior Side Rails:** Crafted with 5mm thick specially made side rails, it perfectly follows the shape and design of your truck's rail parts. This enhances weather insulation and provides a strong, durable installation suitable for heavy-duty use.
- 3. T-Slot Rack for No-Drill Accessories:** Integrate extra accessories like roll bars, side handrails, and cross racks easily with built-in T-slots, eliminating the need for drilling and ensuring a secure fit.
- 4. No-Drill Installation Kits:** Our specially designed kits for roll bars (RB-Kit) and side handrails (KOY-Kit) allow for quick, no-drill installation, supporting light usage up to 70kg.
- 5. Knife-Proof Slats for Ultimate Security:** Ensure 100% load security with knife-proof slats, providing peace of mind for your valuable cargo.
- 6. Internal Locking System (ILS):** Unlock the Tessera SE easily with a strap or internal handle, offering enhanced protection against unauthorized access and smoother operation in all weather conditions.
- 7. Ultimate Weather Proof Systems:** Designed to withstand extreme weather, our system includes oversized drainage systems and main drains capable of

handling up to 60 liters per minute, ensuring your cargo stays dry.

**8. Exclusive Anti-Leaf System (ALS):** Prevent obstruction of water drains with our unique anti-leaf system, a first in the global market for roll-top covers.

**9. Superior Rain Protection:** Specially designed slats with embedded silicon seals offer unmatched protection on rainy days, keeping your truck bed dry and secure.

**10. Maximum Load Capacity:** Featuring the smallest canister on the market, the **Tessera SE** maximizes your truck's loading capacity, providing more space for your cargo.

**11. Easy Installation:** Experience quick and straightforward installation without drilling holes (except from water drains) in the trunk area, making it perfect for any truck setup.

**12. Enhanced Aerodynamics for Fuel Efficiency:** Boost your vehicle's aerodynamics with **Tessera SE**, improving fuel economy and enhancing overall driving experience, especially at high speeds.

### Why Choose Tessera SE?

The **Tessera SE** is the go-to choice for professionals who value efficiency, practicality, and premium quality. Its innovative features, robust design, and superior functionality make it the best manual retractable tonneau bed cover available. Trust **Tessera SE** to provide the ultimate protection and convenience for your pickup truck.

## Roll Bars:

Elevate Your Truck with Our Premium Stainless Steel or Stainless steel painted in Black Matt\* Sport Design Roll Bars.

- **Elevate Your Style:** Our patented design brings a sleek and sporty look to your truck.
- **Built to Last:** Crafted from high-quality 65mm Stainless Steel Pipes (304L) for durability and longevity.
- **Perfect Fit:** Detachable design allows for seamless adaptation to the dimensions of any truck's bed.
- **Ultimate Support:** With a one-piece construction, our roll bar provides strong support, ensuring resistance during loading.
- **Customizable Options:** Includes a special plate for easy installation of fog lamps, enhancing both style and functionality.

- **Safety First:** Offers protection for the cabin in the event of a fall or accident, keeping you and your truck safe on the road.

\* (BLACK MATT: painted in 180°C for 30 minutes, an advanced process certified with the international standards 9001:2000 (Quality Management Systems) & 14001:2004 (Environmental Management Systems) and «SEASIDE CLASS» quality seal of the company QUALICOAT)).

## Tessera4x4 Roll Bars

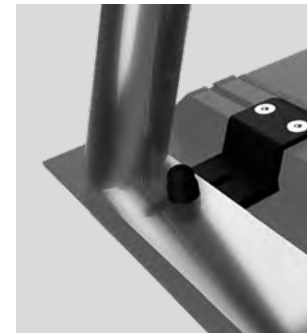

### Presenting our revolutionary RB-KIT:

- **Elevate your Tessera (Roll+ & SE) series** experience with our specially crafted roll bar kit.
- **Seamlessly integrates** into the built-in "T-Slots" without any drilling required.
- **Unlock endless possibilities** for accessorizing without compromising structural integrity.
- **Engineered for** light accessory use, supporting a maximum load of 70kg.

*Elevate your setup effortlessly with our RB-KIT.*



## Tessera Bar+:

### The Ultimate Telescopic Cross Bars for Pickup Trucks

Tessera4x4, the global leader in premium and innovative 4x4 accessories, proudly introduces the **Tessera Bar+**.

This avant-garde, patent-pending product stands alone in the market, delivering unmatched versatility and convenience for pickup truck owners worldwide.

#### Revolutionary Features & Benefits:

##### 1. Groundbreaking Telescopic Design:

- World's First: The **Tessera Bar+** is the first-ever telescopic crossbar system for pickup trucks that can transform into side handrails in under a minute, entirely tool-free.

- Modular Dual Functionality: This innovative design allows you to convert one product into two, maximizing utility and eliminating the need for additional accessories.

##### 2. Ultimate Convenience and Space Efficiency:

- Effortless Transformation: Quickly switch between crossbars and side handrails, ensuring your truck bed is always fully accessible.

- Always Ready: Keep the **Tessera Bar+** with you as side handrails for tying

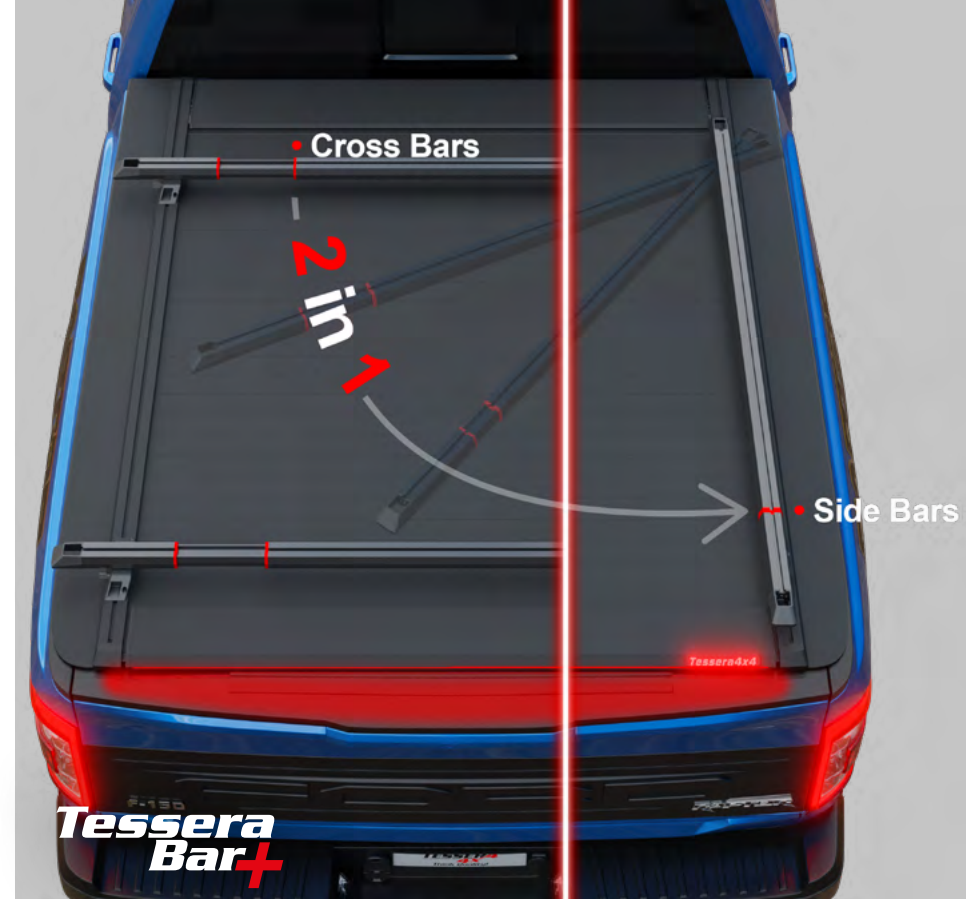

your load safely, avoiding storing it at home, and ensuring it's always ready for use.

##### 3. Seamless Installation & Compatibility:

- Tool-Free Light Use Installation: Designed to fit perfectly into the T-slots of side rails on Tessera4x4 Rolls for light use, supporting up to 70kg (in motion) without the need for drilling.

- Heavy-Duty Versatility: For more demanding applications, it can be installed with drilling to the side

parts, compatible with or without a retractable tonneau bed or roll top cover.

##### 4. Advanced Design Philosophy:

- Built-in T-Slots: Ready for Any Adventure with Built-in T-Slots: The **Tessera Bar+** also integrates effortlessly with extra accessories like ski and bike carriers, tents, and more, thanks to its built-in T-slots. Additionally, you can always rely on the two specially designed side-reinforced plastic finishers for extra tying spots, perfect for light-use applications.

This innovative solution combines unmatched versatility, convenience, and the potential for endless customization, making it the ultimate accessory for any pickup truck owner.

- Effortless Accessory Integration & Cohesive Aesthetic: The **Tessera Bar+** follows the same avant-garde design principles as the **Tessera Roll+** & **Tessera SE** series, ensuring a sleek and harmonious look for your vehicle.

**Exclusive Patent-Pending Innovation:** Cutting-Edge Technology: Enjoy the exclusive benefits of the patent-pending design that sets the **Tessera Bar+** apart from any other product on the market.

#### Why Choose Tessera Bar+?

- Unparalleled Versatility: Adapt to any scenario, whether you're on the job or off-road exploring.

- Robust and Reliable: Engineered with premium materials to withstand the toughest conditions and deliver consistent performance.

- User-Centric Design: Quick and hassle-free installation and transformation save you time and effort, enhancing your overall experience.

- Upgrade your pickup truck with the **Tessera Bar+** and embrace the future of 4x4 accessories.

- Experience the unique blend of innovation, versatility, and superior quality that only Tessera4x4 can offer.

- Transform your vehicle with the **Tessera Bar+** and elevate your 4x4 adventures to unparalleled heights.

## Tessera Divider+:

### Innovative 2-in-1 Modular Trunk Divider

Introducing the **Tessera Divider+**, the revolutionary modular & 2-in-1 trunk divider for pickup trucks.

As the latest innovation from Tessera4x4 Accessories, the global leader in premium 4x4 accessories, the **Tessera Divider+** is designed to redefine convenience, versatility, and functionality for pickup truck owners. This patent-pending product integrates seamlessly with **Tessera Roll+** & **Tessera SE** series, providing the ultimate solution for trunk bed organization & efficiency.

#### Product Features

##### 1. Modular and 2-in-1 Design:

The **Tessera Divider+** is crafted with a modular approach, allowing it to adapt to various needs and uses. It comprises two specially designed aluminum panels that lock together in the middle with a robust latch, forming a solid, unified structure. The panels can be easily separated and stored on the sides of the trunk bed, providing flexibility and maintaining full use of the trunk space.

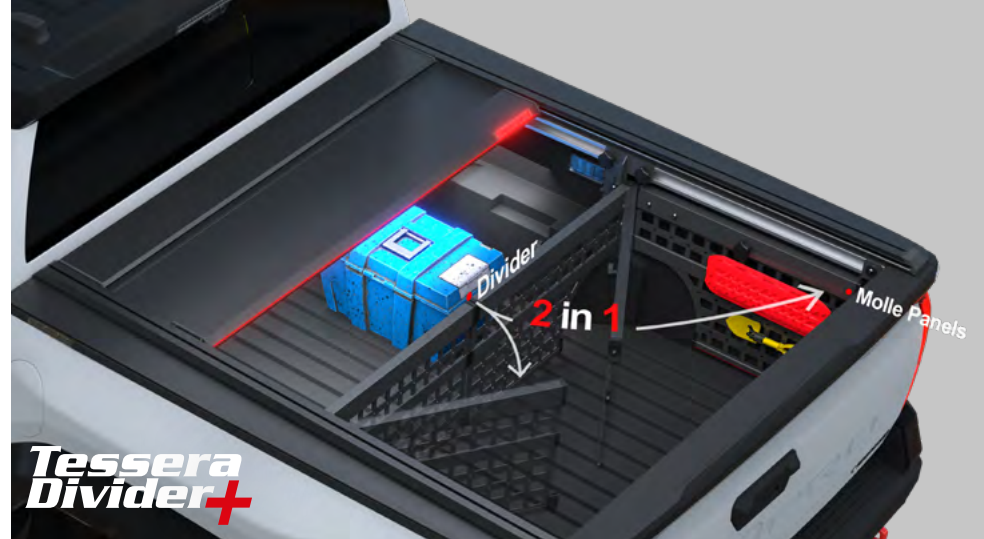

##### 2. Innovative Rolling Mechanism:

Equipped with a unique rolling mechanism, the divider can move forward and backward, ensuring easy adjustment and optimal load management. The specially designed fitting brackets located in the c-channels secure the divider in place, preventing any free movement of the load. The strong construction and robust fitting brackets ensure that the load remains secure during transit. The divider's ability to lock in place prevents any shifting of cargo, enhancing safety and stability.

##### 3. Easy Installation and Storage

No tools are required for installation or removal, making it incredibly user-friendly.

##### 4. Trunk Bed "Molle Panels":

When stored on the sides, the divider panels double as truck bed "Molle Panels," allowing users to tie down

essential equipment like shovels, fire extinguishers, and more. This feature ensures that important tools are always within reach and securely fastened.

#### Benefits & Applications

##### 1. Permanent Trunk Bed Solution:

Users no longer need to uninstall and leave the divider at home. The **Tessera Divider+** can be stored permanently in the trunk bed, providing ongoing convenience and utility.

##### 2. Maximized Trunk Bed Space:

With the ability to store the panels on the sides, users can keep the entire trunk bed free for various loads, maximizing the available space.

##### 3. Enhanced Organization and Accessibility:

The Molle Panel feature allows for better organization of essential tools and equipment, ensuring they are always accessible and securely stored.

##### 4. Increased Load Security:

The strong construction and secure locking mechanism prevent any unwanted movement of the load, enhancing safety during transport.

##### 5. Compatibility with Tessera4x4 Accessories:

The **Tessera Divider+** is designed to work seamlessly with **Tessera Roll+** & **Tessera SE** series, as well as the full line-up of Tessera4x4 Accessories. This compatibility offers a comprehensive solution for trunk bed management, enhancing efficiency and functionality.

##### Why Tessera Divider+

The **Tessera Divider+** is perfect for a wide range of users, including:

- **Outdoor Enthusiasts:** Keep your gear organized and secure during your adventures.
- **Contractors and Tradespeople:** Efficiently manage your cargo and equipment for maximum productivity.
- **Everyday Truck Owners:** Optimize your truck bed space for daily use and various activities.

The **Tessera Divider+** is a game-changer in the world of pickup truck accessories, offering unparalleled convenience, versatility, and functionality. With its innovative design and robust construction, it sets a new standard for trunk bed management. Embrace the future of 4x4 accessories with Tessera4x4 & experience the ultimate in trunk bed efficiency & organization.





Heavy Duty Fitting Brackets



## Tesseract Tower+:

### Redefining Versatility & Strength for Your Truck

Introducing the **Tesseract Tower+**, the latest breakthrough in truck rack systems from Tesseract4x4, a brand synonymous with premium innovation in the 4x4 accessories industry. Whether you're gearing up for weekend adventures or tackling the demands of a busy workweek, the **Tesseract Tower+** adjustable truck rack system offers unparalleled payload capacity, versatility, and customization to meet the highest standards of performance and style.

### Key Features & Innovations

- **Advanced Aluminum Construction for Superior Support**

Specially Designed Aluminum Build: Engineered for exceptional strength and durability, our aluminum construction provides robust support without adding unnecessary weight, ensuring that your truck is always ready for the challenge.

- **Effortless Load Security and Gear Attachment**

Integrated Tie-Down Points: Simplify your load security with strategically placed tie-down points, making it easy to secure your cargo with confidence.

- **T-Slot Attachment Technology:**

Experience the convenience of our T-slot system, designed for fast and easy attachment of gear mounts,

enabling quick customization and enhanced functionality.

- **Unmatched Carrying Capacity for All Your Needs** On-Road and Parked Capacity: The **Tesseract Tower+** offers an impressive 70kg carrying capacity on-road and up to 150kg when parked. Combined with our unique Tesseract4x4 Rolls (**Tesseract Roll+** & **Tesseract SE**), it provides the ideal foundation for daily loads and weekend getaways—all without the need for drilling. (\*Optionally, drilling kits are available for those requiring even greater weight capacity for heavy-duty applications.)

### Customizable Height

- **Adjustable Crossbar Height:**

Tailor the crossbar height to your specific needs with up to +15 cm of adjustability. Whether you need to accommodate long loads over the cab or lower the rack to reduce wind resistance, the **Tesseract Tower+** offers infinite height positions for maximum versatility.

- **Customizable Extended Carrying Space**

- **Telescopic Side Rails:** Extend the length of the entire system by +50 cm with our telescopic side rails, providing additional carrying space and ensuring a perfect fit for your truck.

- **Versatile Side Rail Positioning for Enhanced Utility**

Dual Positioning Options: Customize the placement of the side rails to match your needs. Position them along the side of the construction to reinforce length durability, or place

them on top to increase weight capacity and provide more tie-down spots. This flexibility allows you to optimize your rack for various cargo requirements.

- **Stylish Telescopic Side Panels** For those seeking even more versatility and style, add telescopic (adjustable in height) side panels to each side of the rack. This option, available exclusively with the **Tesseract Roll+** & **Tesseract SE** series, enhances both the aesthetic appeal and functionality of your truck bed.

- **The Ultimate Solution for Professionals and Adventurers**

- **Designed for Every Task:** Whether you're a professional in need of a reliable workhorse or an outdoor enthusiast looking for the perfect adventure companion, the **Tesseract Tower+** is the ultimate solution. With its blend of innovation, strength, and adaptability, it's designed to meet the demands of any challenge you throw at it.
- **Build Your Ideal Truck Rack Today:**
- **Experience the next level of truck rack performance with the Tesseract Tower+.** Customize it to your exact preferences and requirements, and enjoy a product that delivers unmatched versatility, durability, and style. Elevate your truck's capabilities with the **Tesseract Tower+**—where innovation meets excellence.
- **Upgrade to Tesseract Tower+ Now:**
- **Discover the power of versatility.** Equip your truck with the **Tesseract Tower+** and make every journey—whether for work or play—extraordinary.

# The Company

Elevating the standards of innovation and precision, Tessera4x4 Accessories has cemented its position as a trailblazer in the realm of 4x4 vehicle enhancements for over four decades.



With an unwavering commitment to excellence, we have emerged as one of Europe's premier manufacturers for top-of-the-line accessories tailored specifically for pickup trucks and SUVs.

While our stronghold in the Greek market is undeniable, Tessera4x4 Accessories proudly ships products to over 40 countries across five continents, showcasing our global reach and influence. In addition to our renowned roll top covers, our lineup includes Roll Bars, Side handrails, cross racks, and other accessories.

Our design team is dedicated to staying ahead, constantly seeking out the latest trends and technologies to meet the evolving needs of our discerning clientele.

Experience the pinnacle of innovation and excellence with Tessera4x4 Accessories – where passion meets precision to redefine the future of pickup truck accessories.

DISCLAIMER: Vehicles and accessories as shown in this brochure are only for illustration purposes and may vary from the accessories as available in your market. The color of any accessory as shown in this brochure is subject to the limitations of the computer-generated imagery technique and may vary from the color of the actual items. No party can derive any rights from this brochure with respect to any availability or presentation of the vehicles and accessories shown. No part of this brochure may be copied, reproduced, distributed, made available, modified, edited, changed, used or served for any purposes without the prior written approval of Tessera4x4 accessories.

12 PATENTS

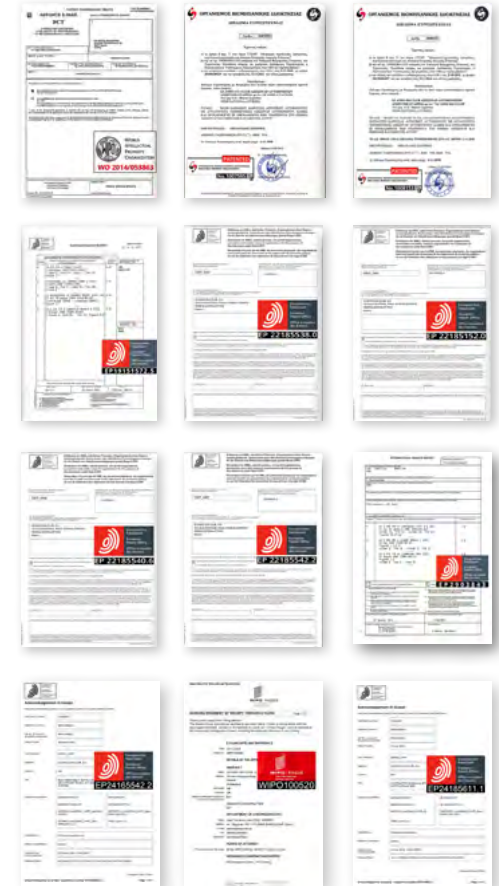

3 TUV CERTIFICATIONS  
+ 2 PENDING (EMC R10 & THE RADIO EQUIPMENT DIRECTIVE (RED, EU DIRECTIVE 2014/53/EU))





**TESSERA**<sup>4</sup>  
OFF ROAD ACCESSORIES

**4X**  
*Think Quality!*

**RAPTOR**

**Tessera4x4  
accessories**

19.5 km EO Athinon Korinthou  
Elefsina, Greece, Zip Code: 19200  
GPS address: 38.050320, 23.564402

Tel: (+30) 210 5542813 - 5541161 - 5541154

Mobile: (+30) 6947901533

Fax: (+30) 210 5541 443

email: [info@gianso.gr](mailto:info@gianso.gr)

[www.tessera4x4.com](http://www.tessera4x4.com)

HERE

DOWNLOAD



ON SOCIAL MEDIA

FOLLOW US

