

00029

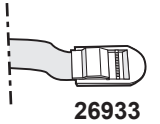

00398

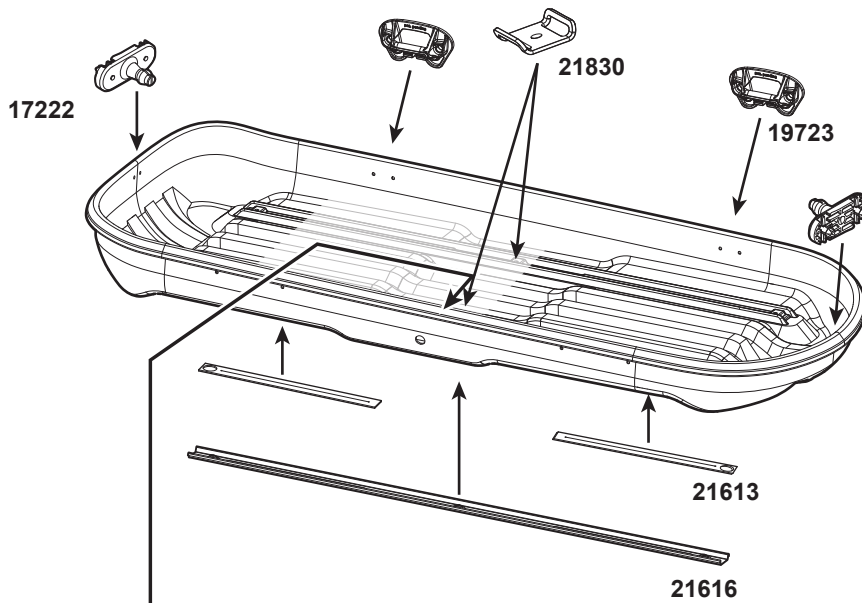

26933

MANUAL



27002

SYSTEM A

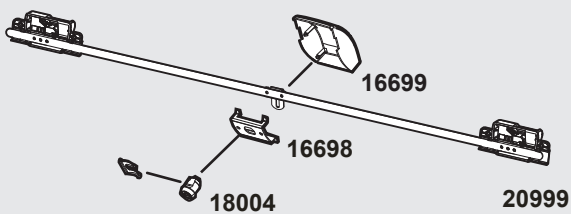

No.:

| | | | |
|---|---|--|--|
| 2 | 5 | | |
|---|---|--|--|

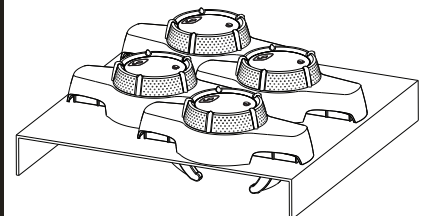

ART.NO: 27000

SYSTEM B

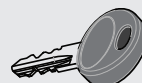
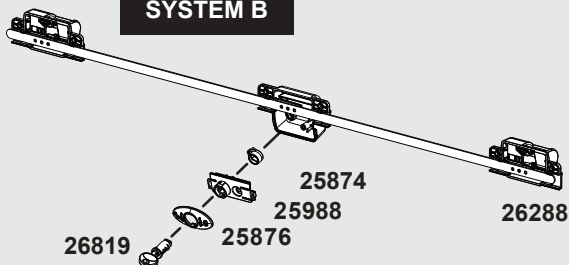

No.:

| | | | |
|---|--|--|--|
| 2 | | | |
|---|--|--|--|

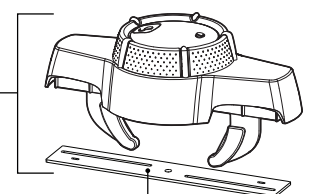

ART.NO: 27001

ART.NO: 27001